



iota international



The Leading Manufacturer & Exporter of Electronic Products & Accessories Since 1996

B-47, East Uttam Nagar, New Delhi-110059 (INDIA) Contact no. 011-28566590 9810021697 sales@iota.in

Electronic Siren, Emergency Panic Switches, Panic Alarm, LED Light, SMPS & Accessories

SPECIFICATION OF BEACON LIGHT – BL164

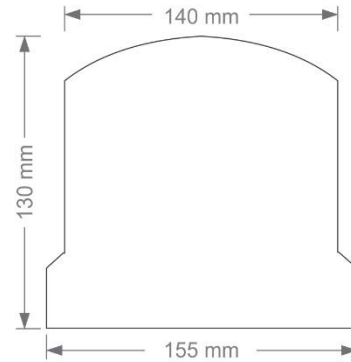

All dimension are in mm tolerance ± 0.2 mm

- Product : Beacon Light
- Model Number : BL164
- Operating Voltage : 12Volt / 24Volt DC
- Current : 2Amp (at 12Volt DC)
- Revolution per Minutes : 80-96 RPM
- Wattage : 55 Watt
- Material of Glass : Polycarbonate
- Color : Red / Blue
- Lead Time : 15 Days
- MOQ : 50 Units
- Warranty : One year against any manufacturing defect

Important Notes:

Tones : We can provide all type international and Indian standard Siren/Alarm tones along with customized tones.

Voltage : This product is also available in 6V / 9V / 12V/ 18V / 24V DC & 220V AC

We also welcome Customer's Design & Specifications, For more Product Log on www.iotasiren.com

